

## 2 – 26 GHz GaAs Distributed Self-Biased LNA

### Product Overview

MMA042AA is a Gallium Arsenide (GaAs) monolithic microwave integrated circuit (MMIC) Pseudomorphic HighElectron Mobility Transistor (PHEMT) distributed amplifier die that operates between 2 GHz and 26 GHz. It is ideal for test instrumentation, defense, and space applications. The amplifier provides a 2 dB positive gain slope with a typical gain of 18 dB, 2 dB noise figure, 19 dBm of output power at 1 dB gain compression, and 29 dBm output IP3 at 10 GHz. The MMA042AA amplifier features RF I/Os that are internally matched to 50 Ohm, which allows for easy integration into multi-chip modules (MCMs).

#### Key Features

- **Frequency range: 2 to 26 GHz**
- **High Gain: 18 dB with +2 dB upslope**
- **Low Noise figure: 2.5 dB**
- **High Output IP3: + 29 dBm**
- **Maximum RF Input Power: + 24 dBm**
- **Single Positive Supply: +6V @ 120 mA**
- **50 Ohm matched input/output**
- **ESD Protection on RF and DC ports**
- **Die size: 2.020 x 1.630 mm**

#### Functional Block Diagram

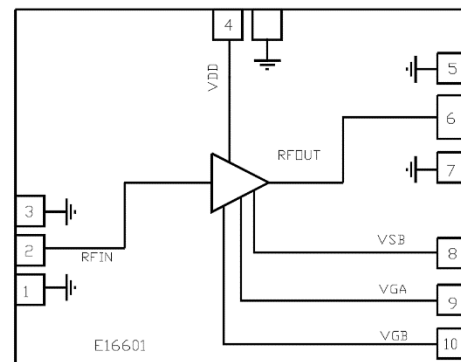

Figure 1 - Typical Responses

### Applications

- Test and measurement instrumentation
- Electronic warfare (EW), electronic countermeasures (ECM), and electronic counter-countermeasures (ECCM)
- Military and space
- Telecom infrastructure
- Wideband microwave radios
- Microwave and millimeter-wave communications systems

#### Performance Overview

Parameter	Typ.	Units
Operational frequency range	2-26	GHz
Gain	18	dB
OIP3	29	dBm
NF	2.5	dB
Current @ +6V Supply	120	mA

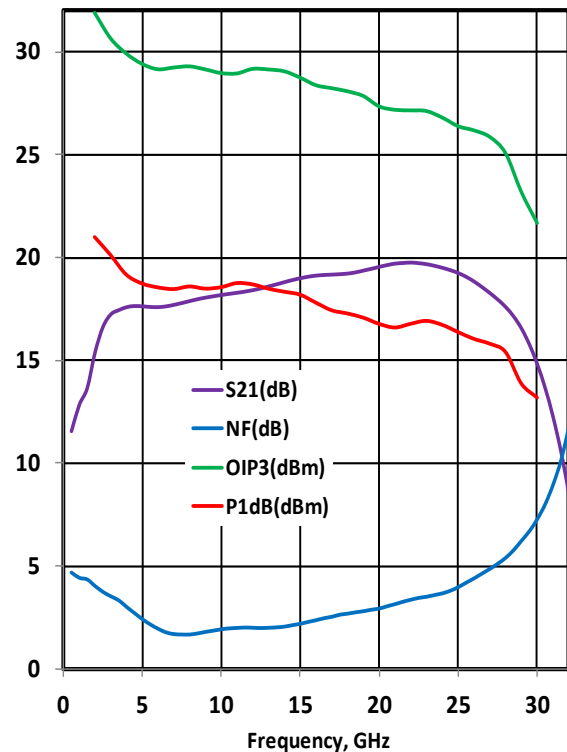

Export Classification: EAR-99

## Table of Contents

1. Electrical Specifications .....	3
1.1. Typical Electrical Performance .....	3
1.2. Absolute Maximum Ratings.....	4
1.3. Typical Performance Curves .....	4
1.3.1 Typical Performances vs. Temperature.....	4
1.3.2 Typical Performances vs. Bias.....	11
1.3.3 Typical Performances vs. Output Power.....	14
1.4. Die Specifications .....	16
2. Application Circuits.....	18
3. Handling Recommendations.....	20
4. Ordering Information.....	20
4.1. Packing Information.....	20

## 1. Electrical Specifications

### 1.1. Typical Electrical Performance

Table 1 - Typical Electrical Performance at 25 C, Vdd=6V, Idd=120 mA (Unless otherwise mentioned)

Parameter	Frequency Range	Min	Typ.	Max	Units
Frequency range		2		26	GHz
Gain	3 - 8 GHz	16	18		dB
	8 - 15 GHz	17	18.5		dB
	15 – 26 GHz	18	20		dB
Gain flatness	3 - 8 GHz		± 0.5		dB
	8 - 15 GHz		± 0.5		dB
	15 – 26 GHz		± 1		dB
Noise figure	3 - 8 GHz		2.5	3.5	dB
	8 - 15 GHz		2	2.5	dB
	15 – 26 GHz		3.5	6	dB
Input return loss	3 - 8 GHz		12		dB
	8 - 15 GHz		12		dB
	15 – 26 GHz		10		
Output return loss	3 - 8 GHz		10		dB
	8 - 15 GHz		10		dB
	15 – 26 GHz		10		dB
P1dB	3 - 8 GHz	18	20		dBm
	8 - 15 GHz	18	20		dBm
	15 – 26 GHz	16	18		dBm
Psat (Measured at 3dB Gain Compression)	3 - 8 GHz				dBm
	8 - 15 GHz				dBm
	15 – 26 GHz				dBm
OIP3	3 - 8 GHz		30		dBm
	8 - 15 GHz		30		dBm
	15 – 26 GHz		28		dBm
Phase Noise			TBD		dBm/Hz
OIP2(low) (2-nd Order Intercept point F2-F1)			TBD		dBm
VDD (drain voltage supply)			6		V
IDD (drain current)			120		mA

## 1.2. Absolute Maximum Ratings

The following table shows the absolute maximum ratings of the MMA042AA device at 25 °C, unless otherwise specified. Exceeding one or any of the maximum ratings potentially could cause damage or latent defects to the device.

Table 2 - Absolute Maximum Ratings

Parameter	Rating
Drain bias voltage ( $V_{DD}$ )	8 V
Gate bias voltage ( $V_G$ )	-2 V to 0.5 V
RF input power ( $P_{in}$ )	24 dBm
Channel temperature	150 °C
$V_{DD}$ current ( $I_{DD}$ )	200 mA
DC power dissipation ( $T = 85\text{ °C}$ )	1.6 W
Thermal resistance	17°C/W
Storage temperature	-65 °C to 150 °C
Operating temperature	-55 °C to 85 °C



ESD Sensitive Device

## 1.3. Typical Performance Curves

### 1.3.1 Typical Performances vs. Temperature

The following graphs show the typical performance curves of the MMA042AA device at specific bias conditions, measurements performed using application circuit shown on Figure 70 - below.

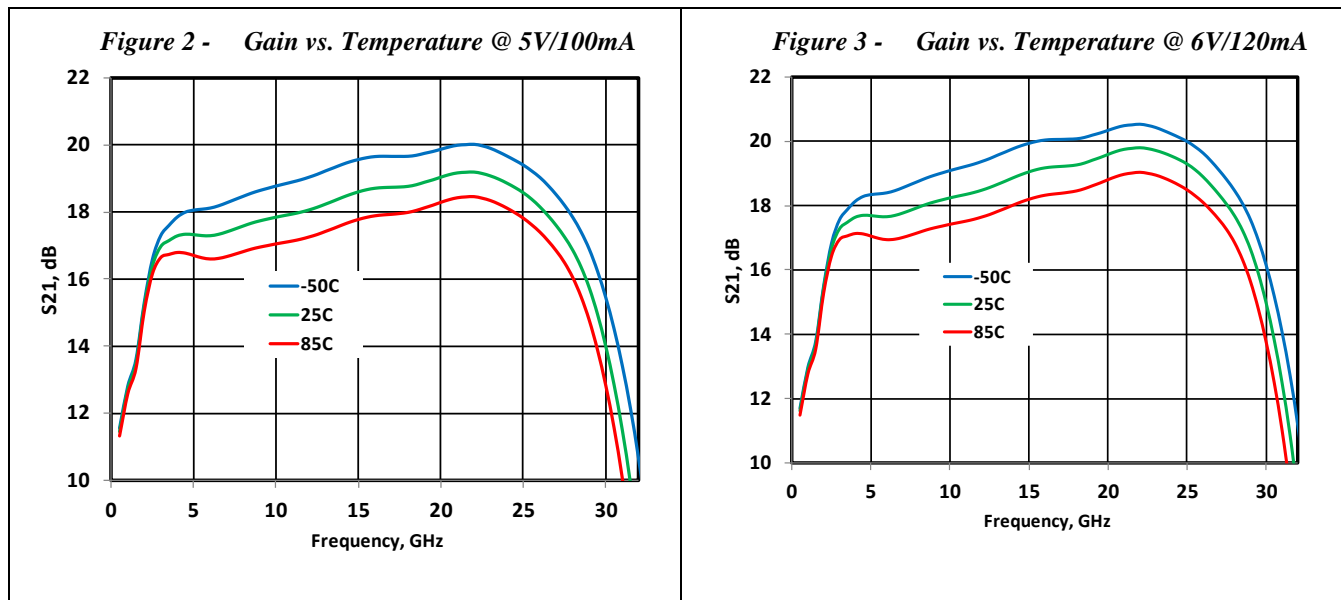

Figure 4 - Gain vs. Temperature @ 7V/140mA

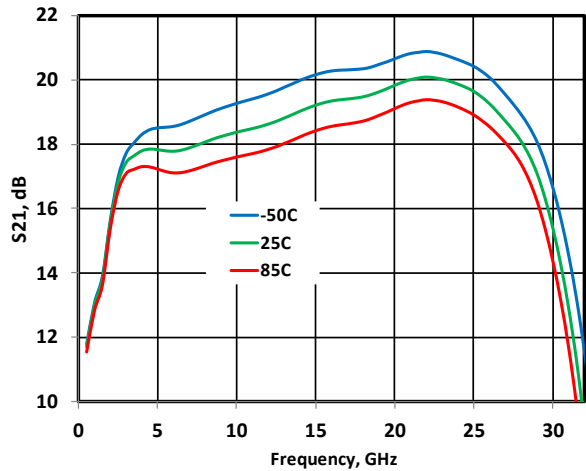

Figure 5 - Gain vs. Temperature @ 3.5V/60mA

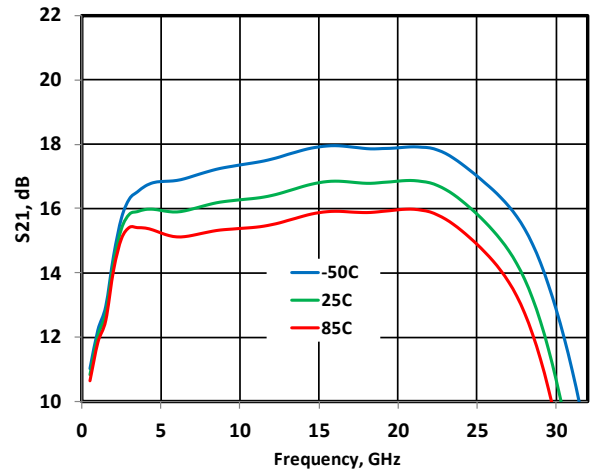

Figure 6 - S11 vs. Temperature @ 5V/100mA

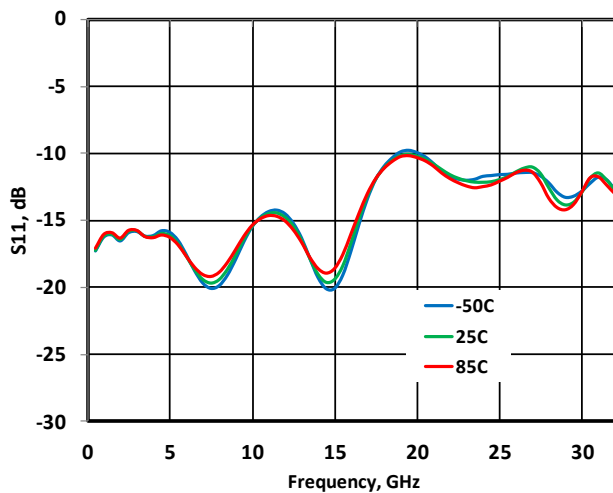

Figure 7 - S11 vs. Temperature @ 6V/120mA

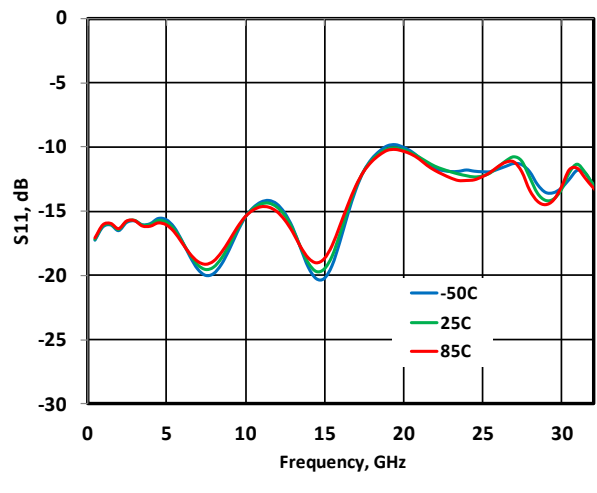

Figure 8 - S11 vs. Temperature @ 7V/140mA

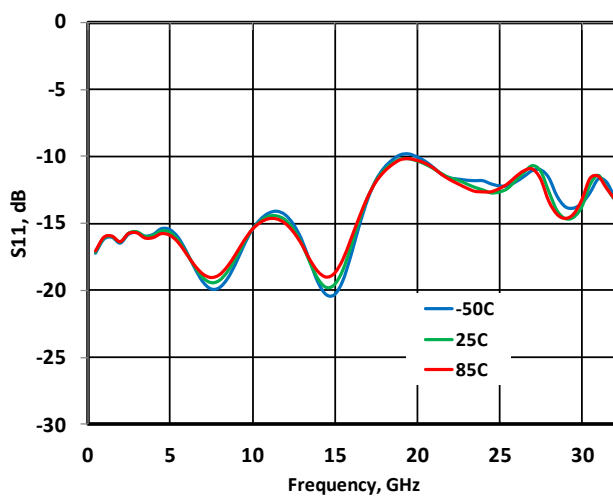

Figure 9 - S11 vs. Temperature @ 3.5V/60mA

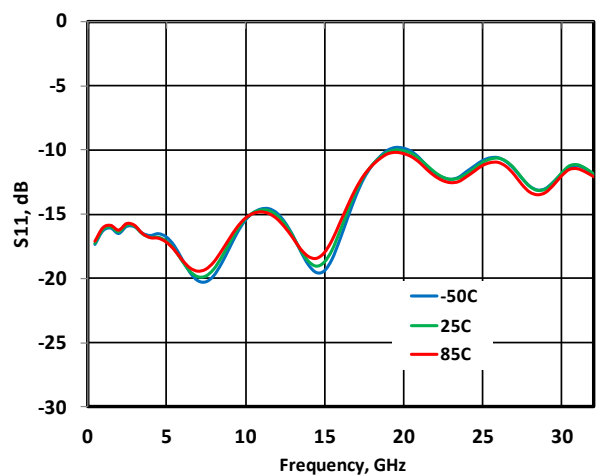

Figure 10 - S22 vs. Temperature @ 5V/100mA

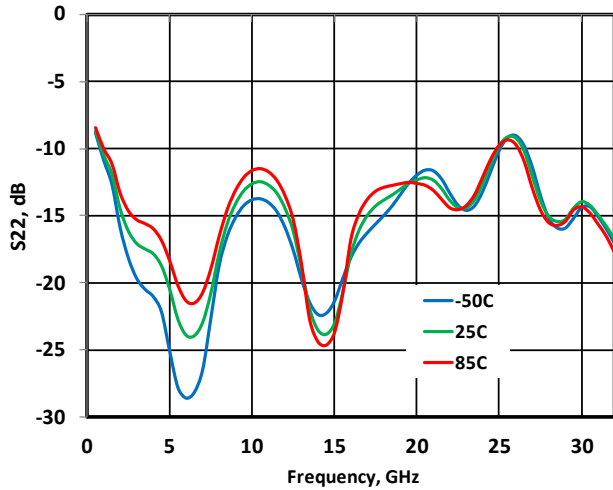

Figure 11 - S22 vs. Temperature @ 6V/120mA

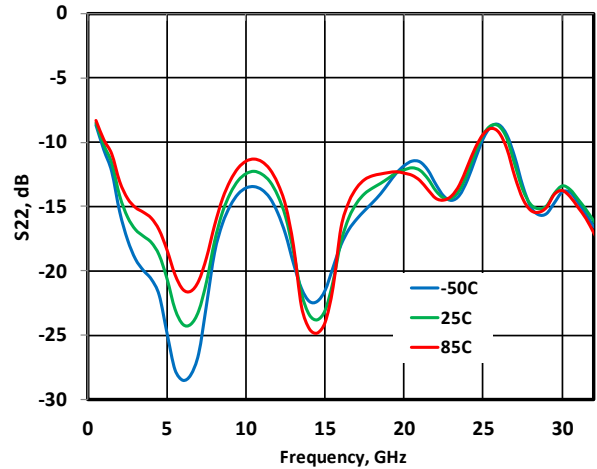

Figure 12 - S22 vs. Temperature @ 7V/140mA

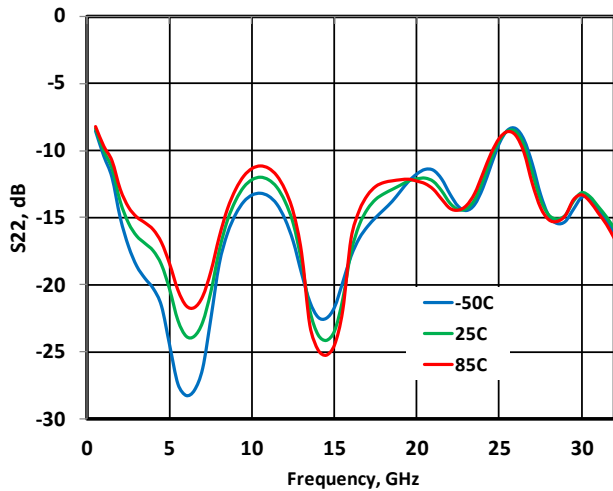

Figure 13 - S22 vs. Temperature @ 3.5V/60mA

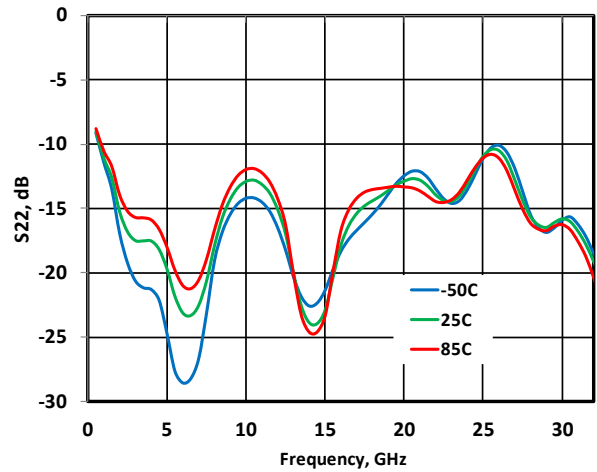

Figure 14 - S12 vs. Temperature @ 5V/100mA

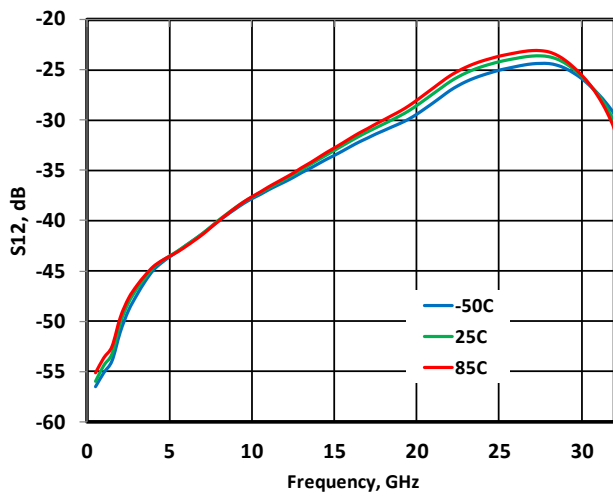

Figure 15 - S12 vs. Temperature @ 6V/120mA

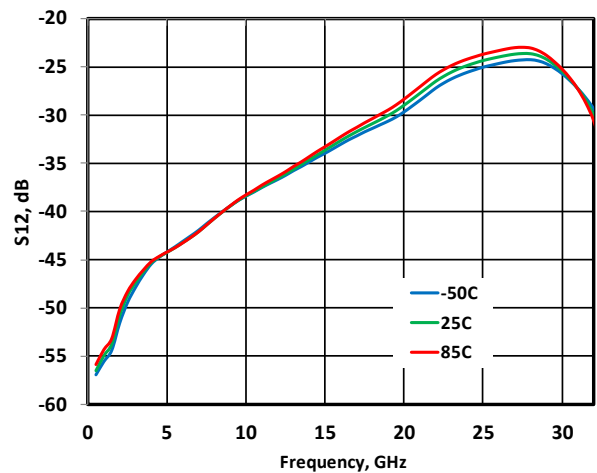

Figure 16 - S12 vs. Temperature @ 7V/140mA

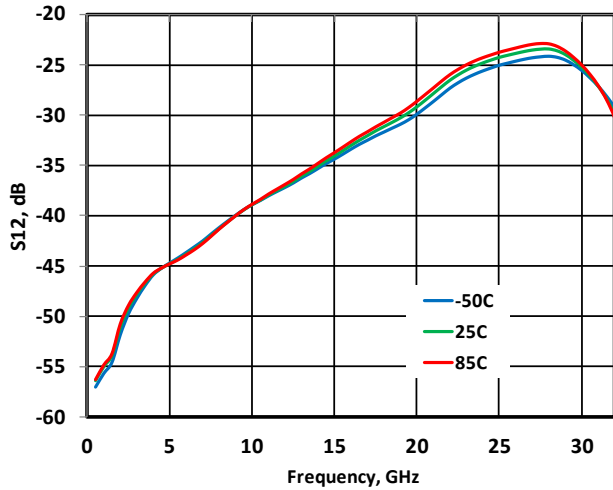

Figure 17 - S12 vs. Temperature @ 3.5V/60mA

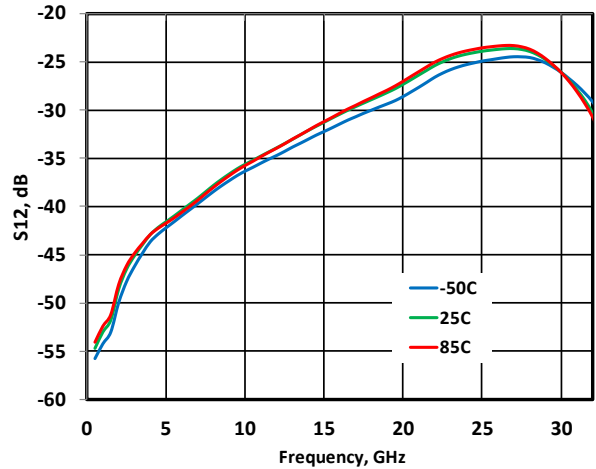

Figure 18 - NF vs. Temperature @ 5V/100mA

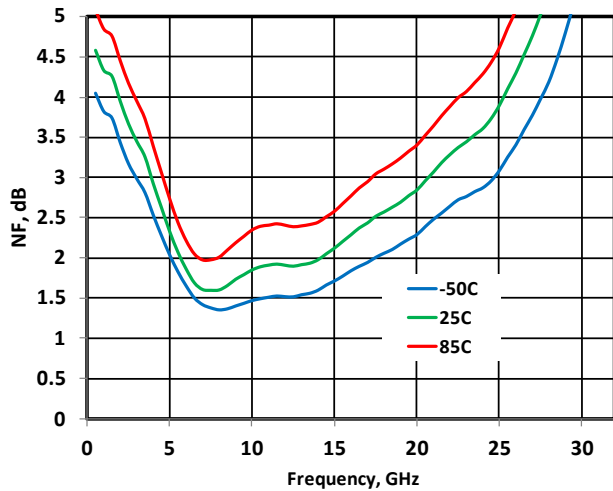

Figure 19 - NF vs. Temperature @ 6V/120mA

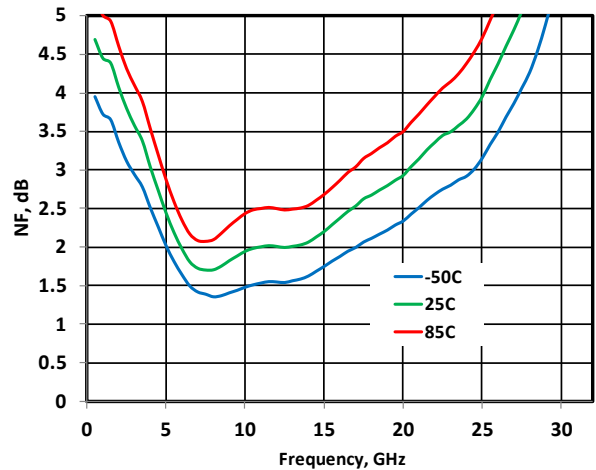

Figure 20 - NF vs. Temperature @ 7V/140mA

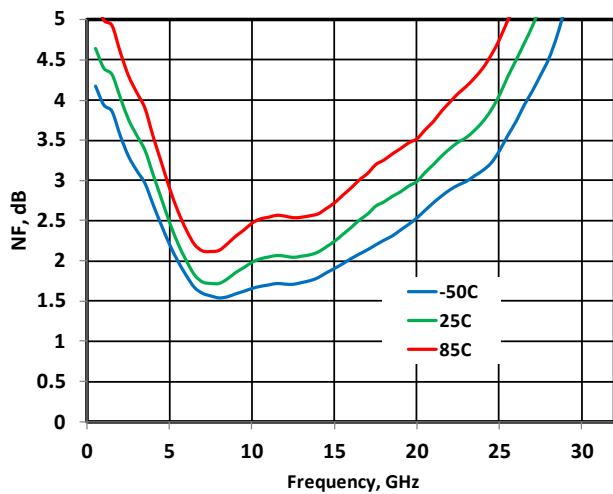

Figure 21 - NF vs. Temperature @ 3.5V/60mA

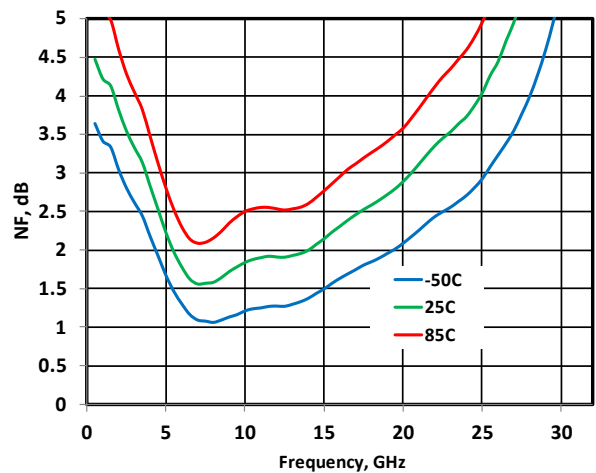

Figure 22 - P1dB vs. Temperature @ 5V/100mA

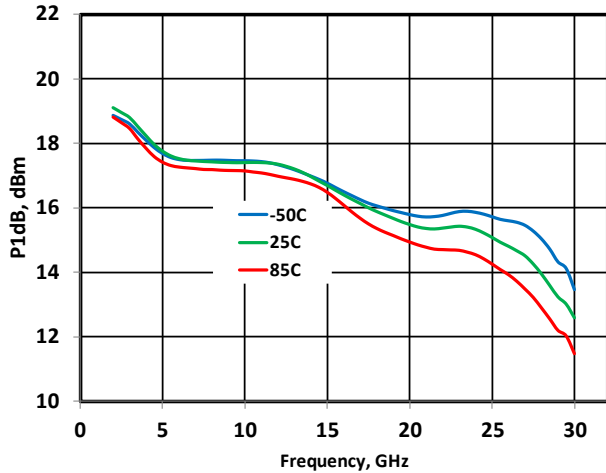

Figure 23 - P1dB vs. Temperature @ 6V/120mA

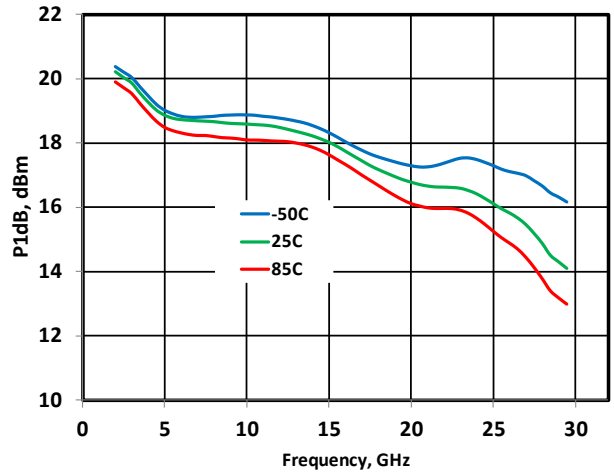

Figure 24 - P1dB vs. Temperature @ 7V/140mA

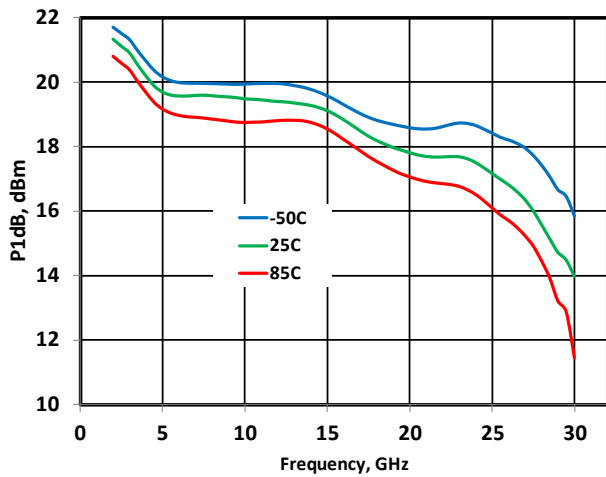

Figure 25 - P1dB vs. Temperature @ 3.5V/60mA

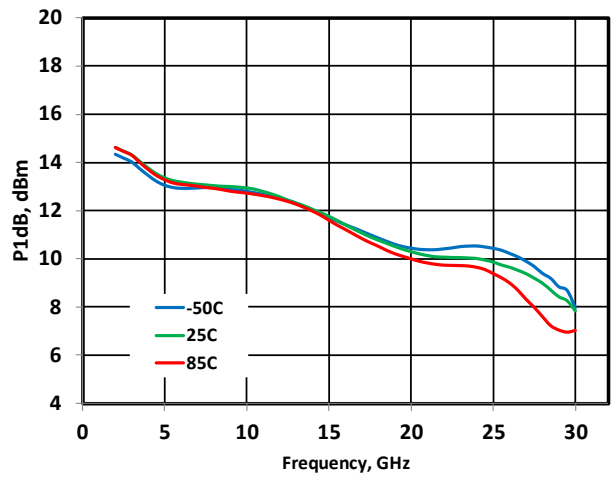

Figure 26 - Psat vs. Temperature @ 5V/100mA

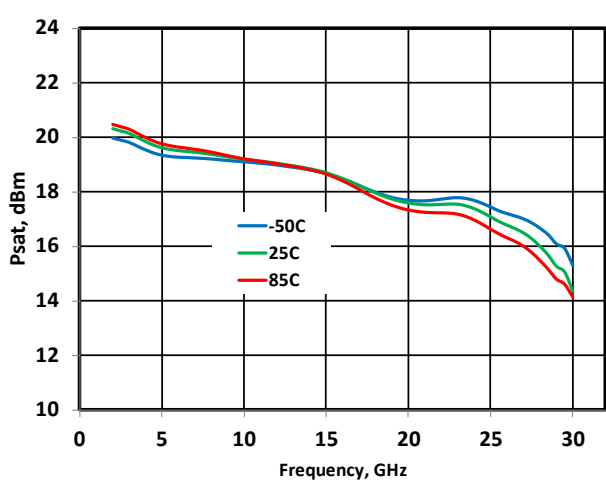

Figure 27 - Psat vs. Temperature @ 6V/120mA

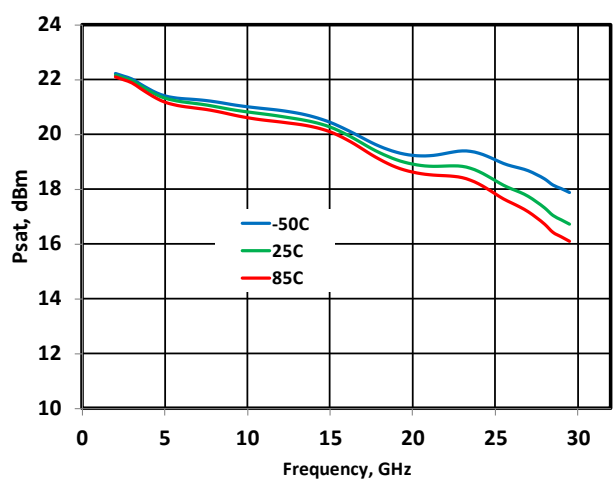

Figure 28 - Psat vs. Temperature @ 7V/140mA

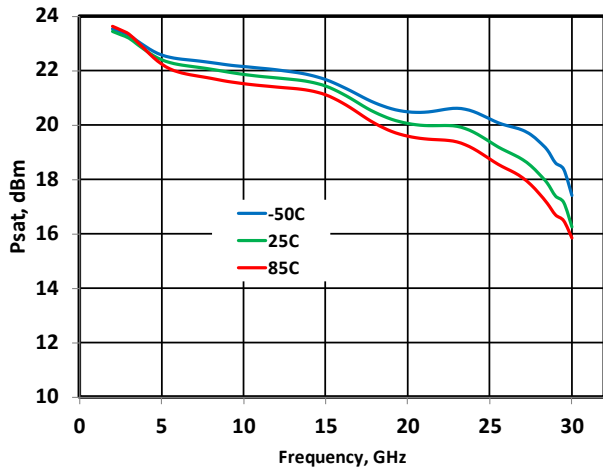

Figure 29 - Psat vs. Temperature @ 3.5V/60mA

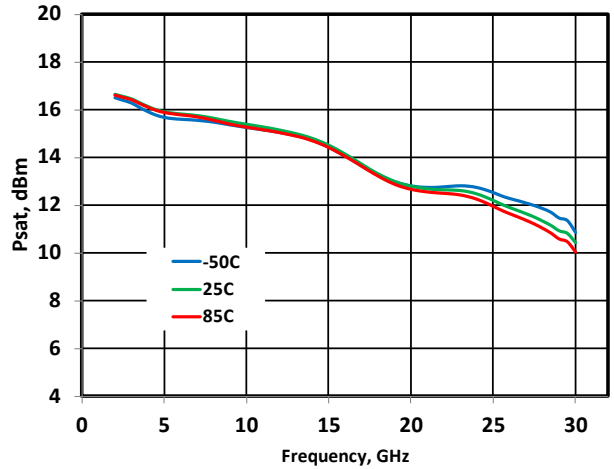

Figure 30 - OIP3 vs. Temperature @ 5V/100mA

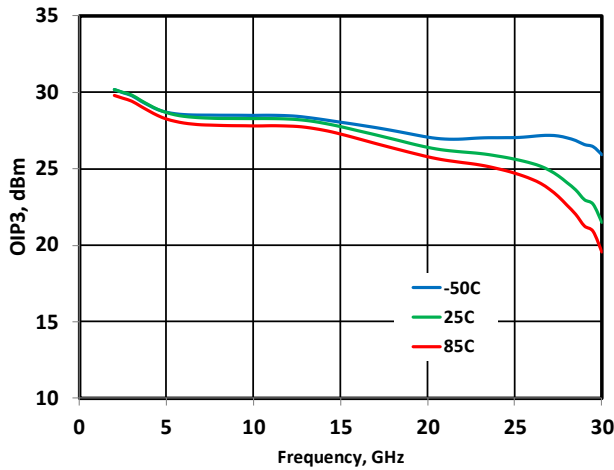

Figure 31 - OIP3 vs. Temperature @ 6V/120mA

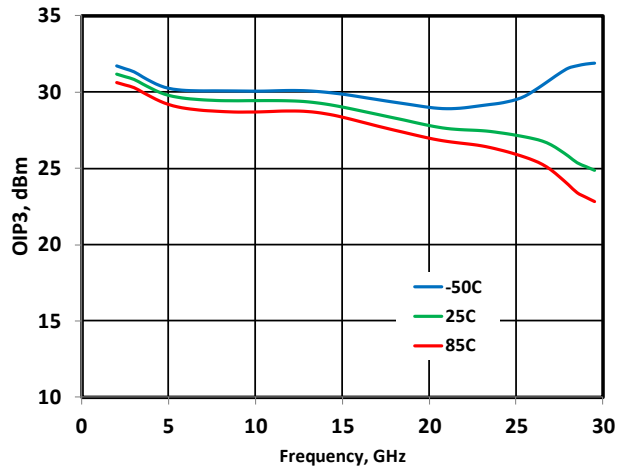

Figure 32 - OIP3 vs. Temperature @ 7V/140mA

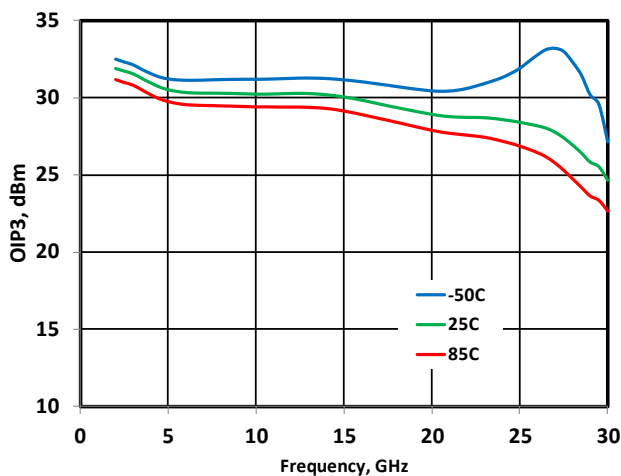

Figure 33 - OIP3 vs. Temperature @ 3.5V/60mA

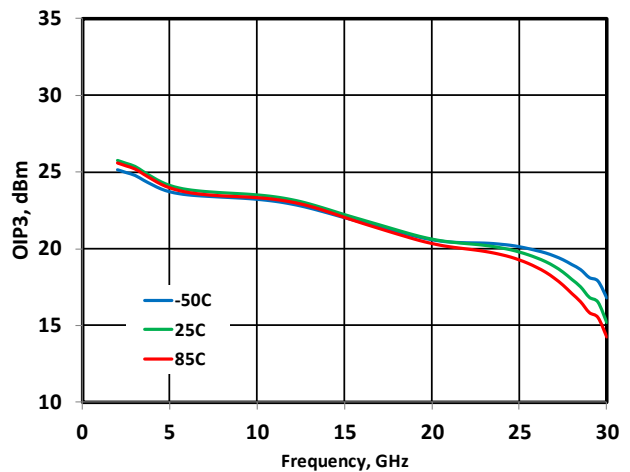

Figure 34 - OIP2(low) vs. Temperature @ 5V/100mA

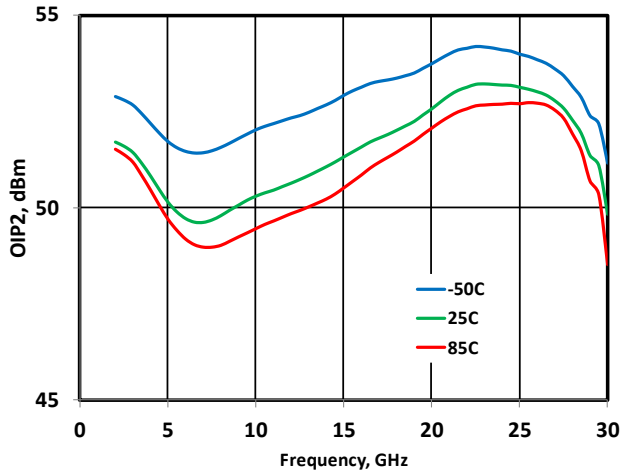

Figure 35 - OIP2(low) vs. Temperature @ 6V/120mA

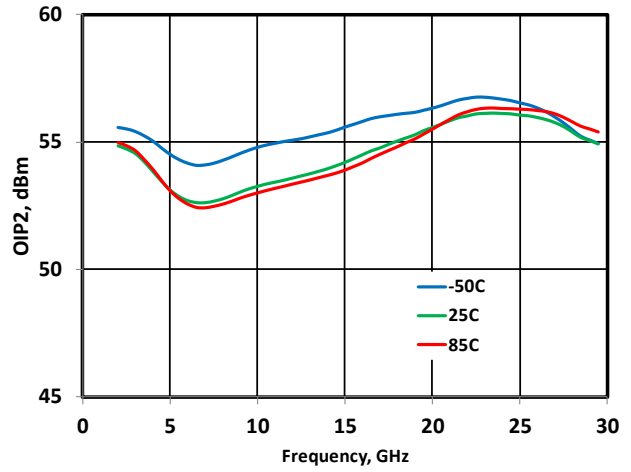

Figure 36 - OIP2(low) vs. Temperature @ 7V/140mA

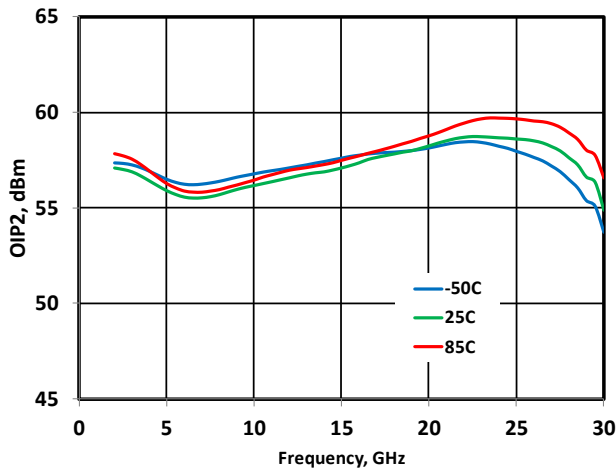

Figure 37 - OIP2(low) vs. Temperature @ 3.5V/60mA

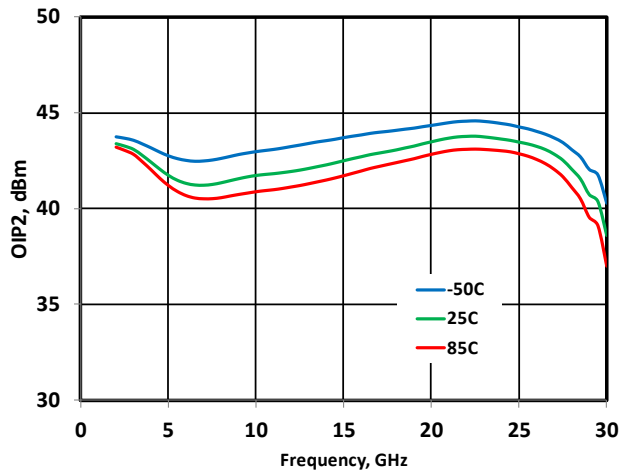

Figure 38 - IM3 vs. Temperature @ 5V/100mA, 10dBm(per tone)

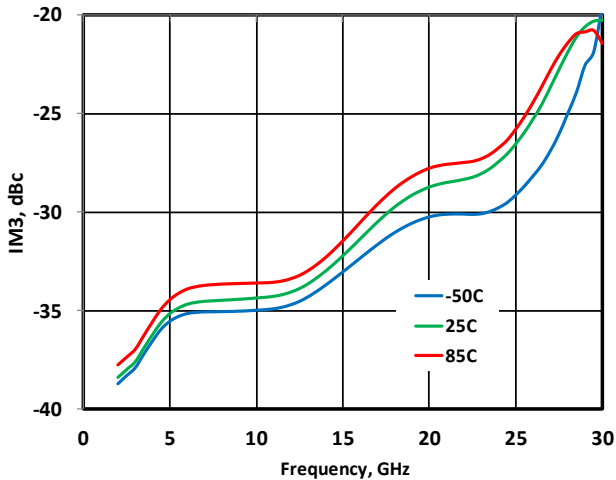
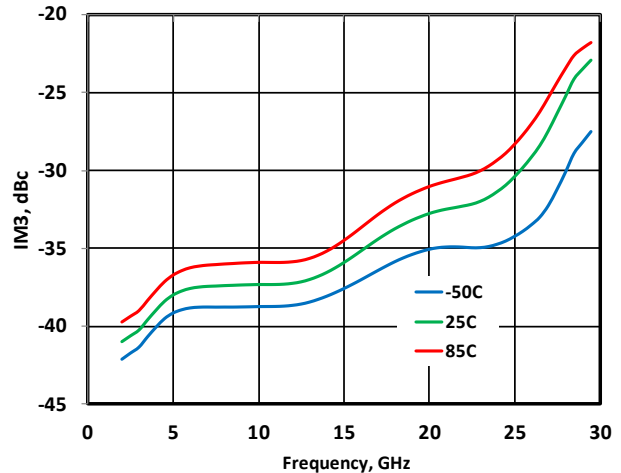
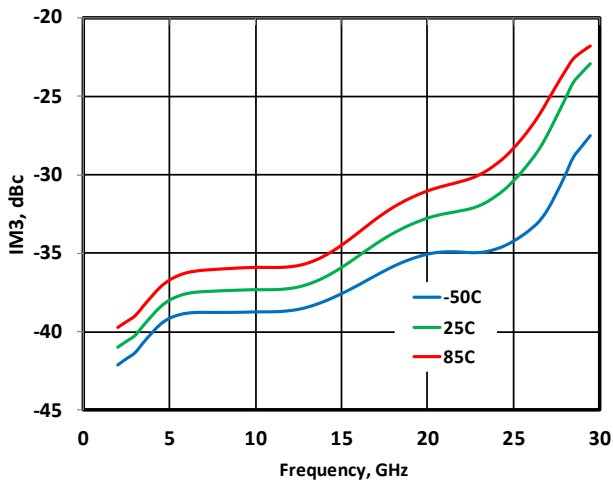

Figure 39 - IM3 vs. Temperature @ 6V/120mA, 10dBm(per tone)



**Figure 40 - IM3 vs. Temperature @ 7V/140mA, 10dBm(per tone)**



**Figure 41 - IM3 vs. Temperature @ 3.5V/60mA**

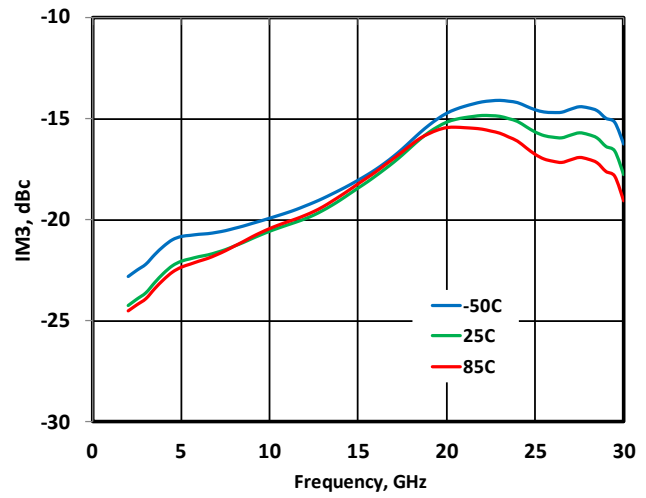

### 1.3.2 Typical Performances vs. Bias

The following graphs show the typical performance curves of the MMA042AA device at 25 °C vs. Bias conditions, measurements performed using application circuit shown on Figure 70 - below.

**Figure 42 - Gain vs.  $V_{DD}$  @ 100mA**

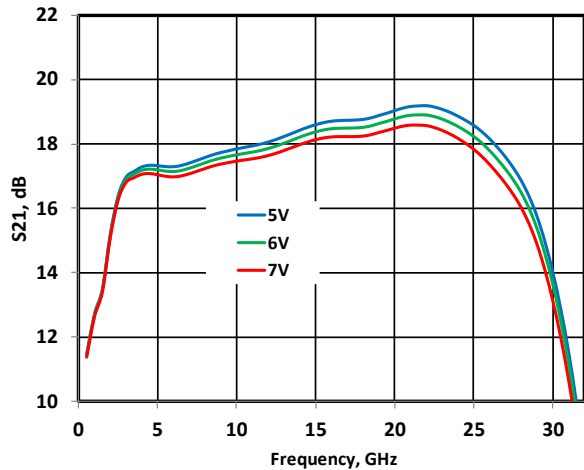

**Figure 43 - Gain vs.  $V_{DD}$  @ 120mA**

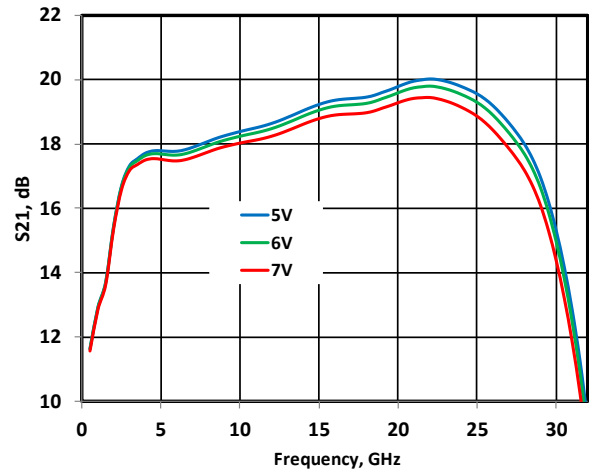

Figure 44 - Gain vs.  $V_{DD}$  @ 130mA

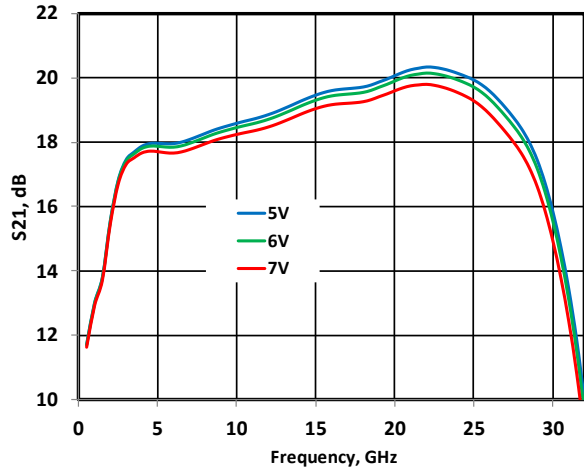

Figure 45 - Gain @ 3.5V/60mA

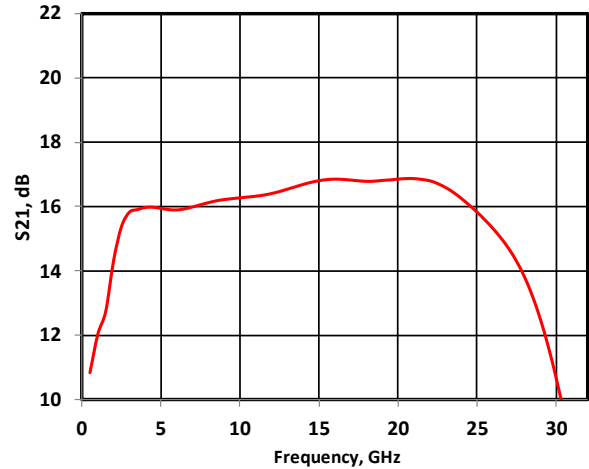

Figure 46 - NF vs.  $V_{DD}$  @ 100mA

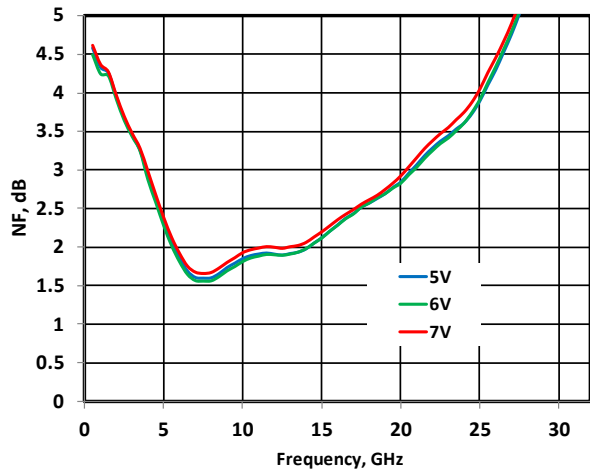

Figure 47 - NF vs.  $V_{DD}$  @ 120mA

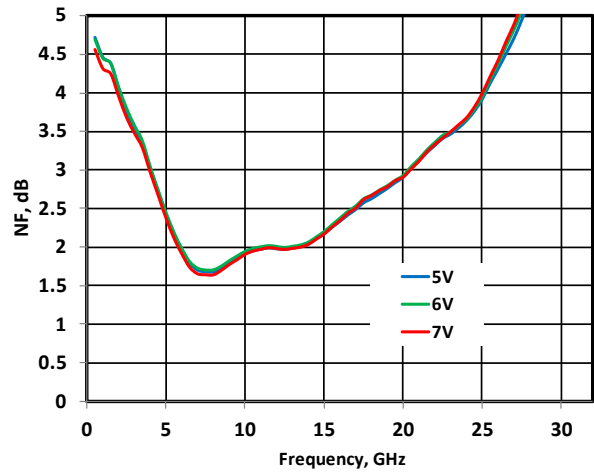

Figure 48 - NF vs.  $V_{DD}$  @ 130mA

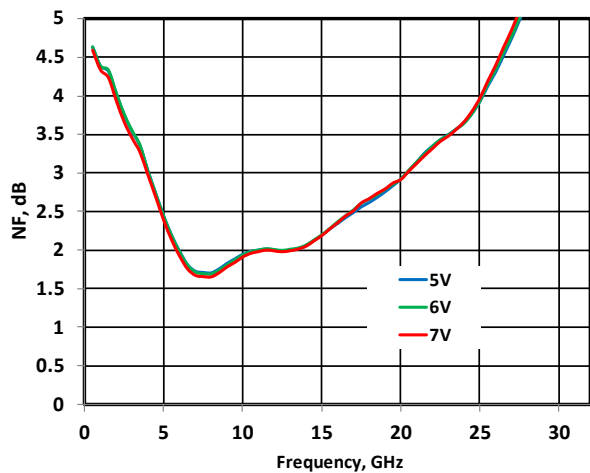

Figure 49 - NF @ 3.5V/60mA

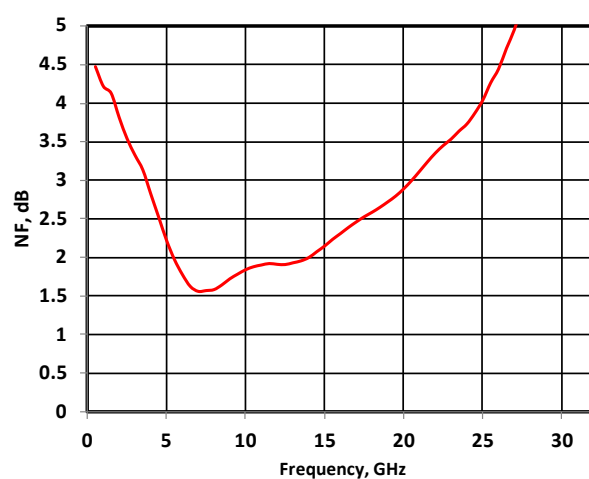

Figure 50 - P1dB vs. V<sub>DD</sub>/I<sub>DD</sub>

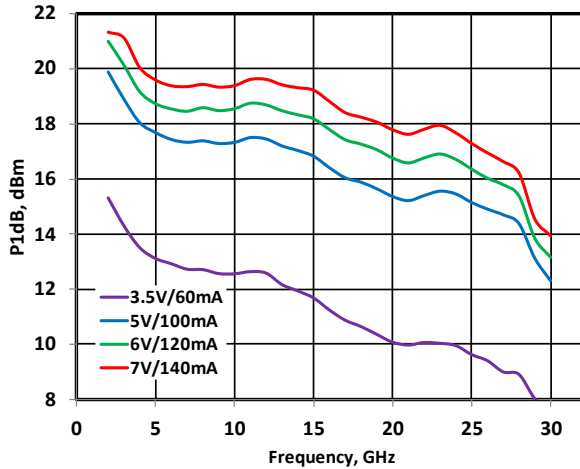

Figure 51 - P<sub>sat</sub> vs. V<sub>DD</sub>/I<sub>DD</sub>

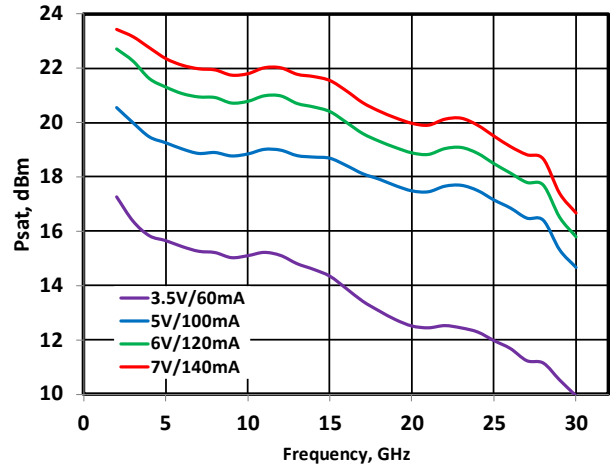

Figure 52 - OIP<sub>3</sub> vs. V<sub>DD</sub>/I<sub>DD</sub>

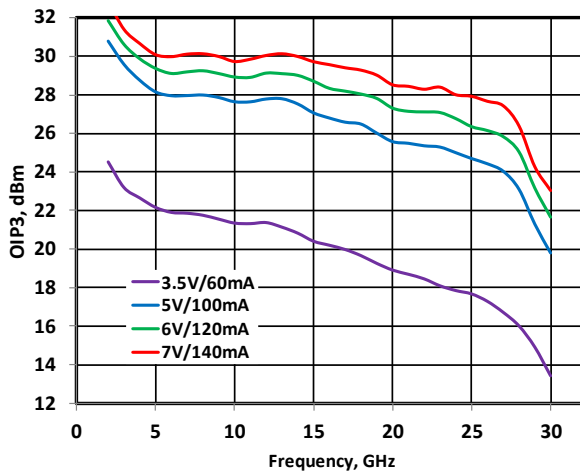

Figure 53 - OIP<sub>2</sub> Low at D=250MHz vs. V<sub>DD</sub>/I<sub>DD</sub>

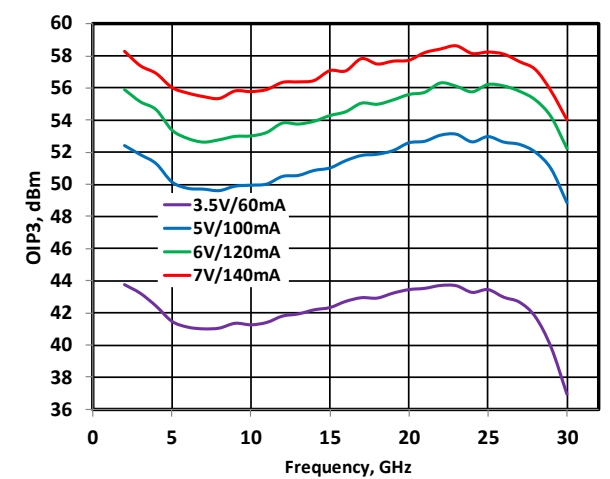

Figure 54 - IM<sub>3</sub> vs. V<sub>DD</sub>/I<sub>DD</sub>, 10dBm(per tone)

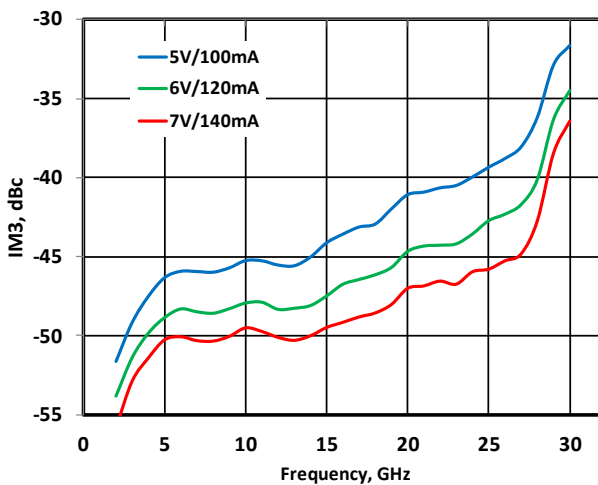
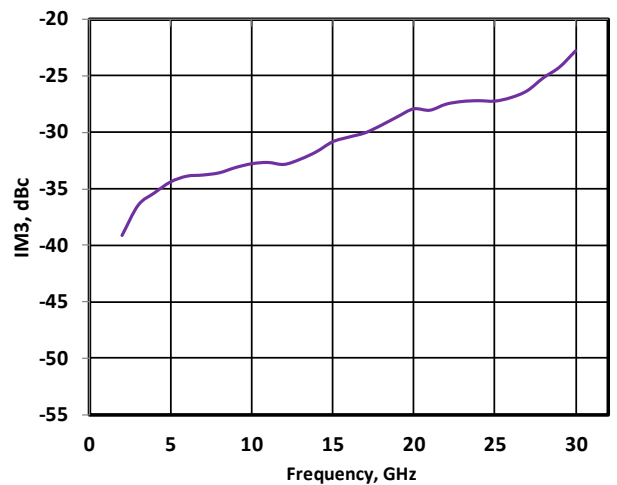

Figure 55 - IM<sub>3</sub> at 3.5V/60mA, 5dBm(per tone)



### 1.3.3 Typical Performances vs. Output Power

The following graphs show the typical performance curves of the MMA042AA device at 25 °C vs. Output Power conditions, measurements performed using application circuit shown on Figure 70 - below.

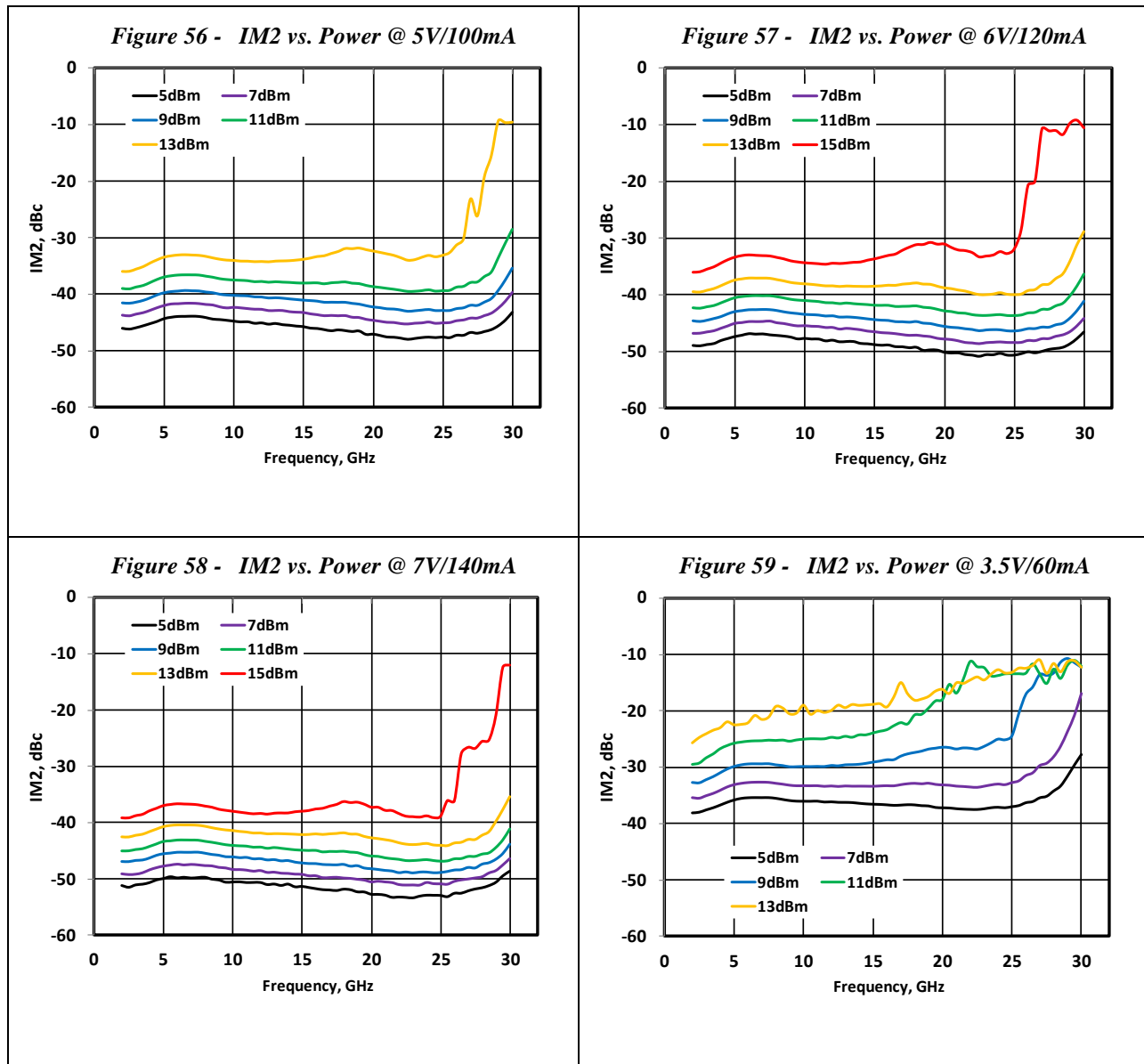

Figure 60 - IM3 vs. Power @ 5V/100mA

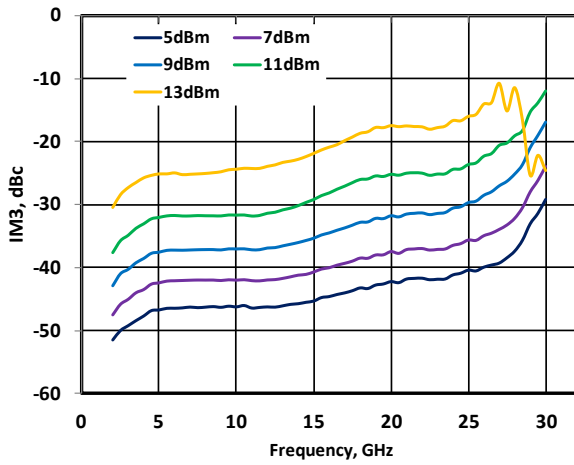

Figure 61 - IM3 vs. Power @ 6V/120mA

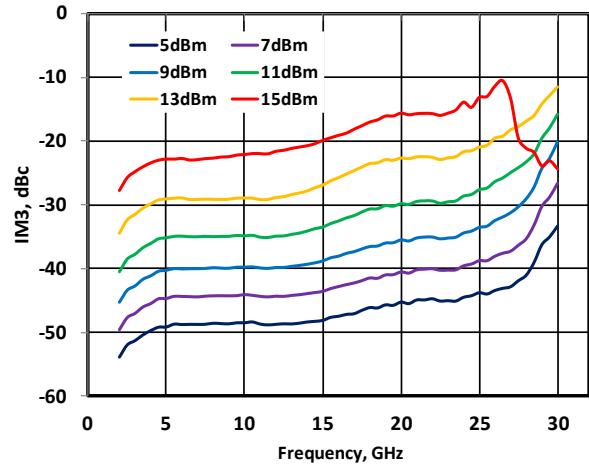

Figure 62 - IM3 vs. Power @ 7V/140mA

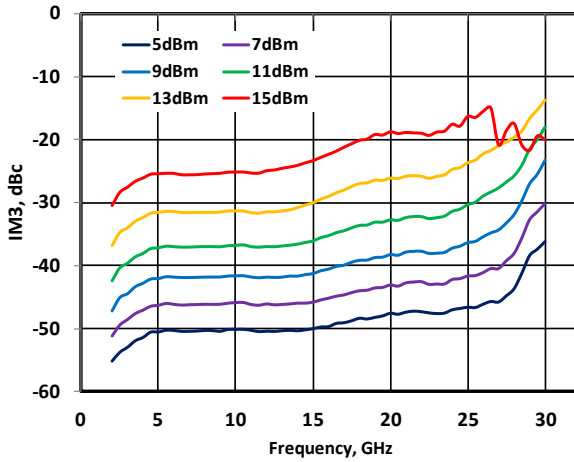

Figure 63 - IM3 vs. Power @ 3.5V/60mA

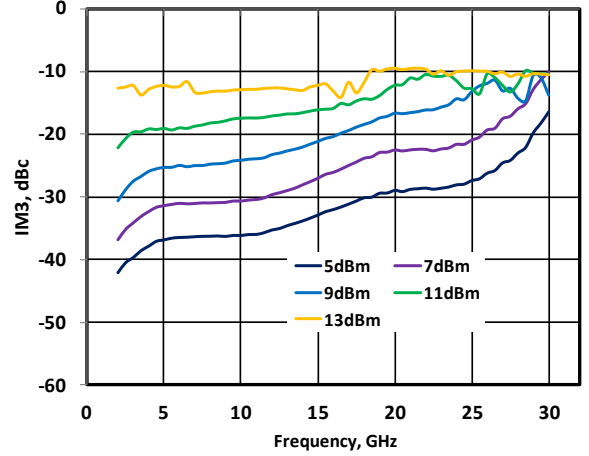

Figure 64 - 2-nd Harmonic vs. Power @ 5V/100mA

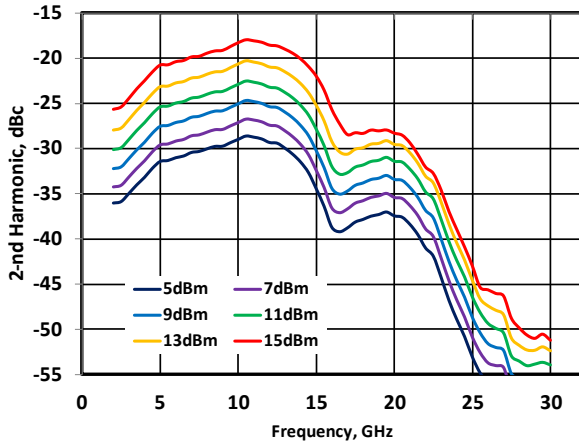
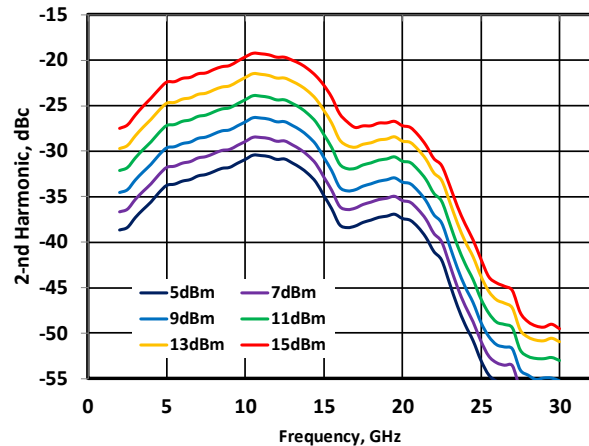
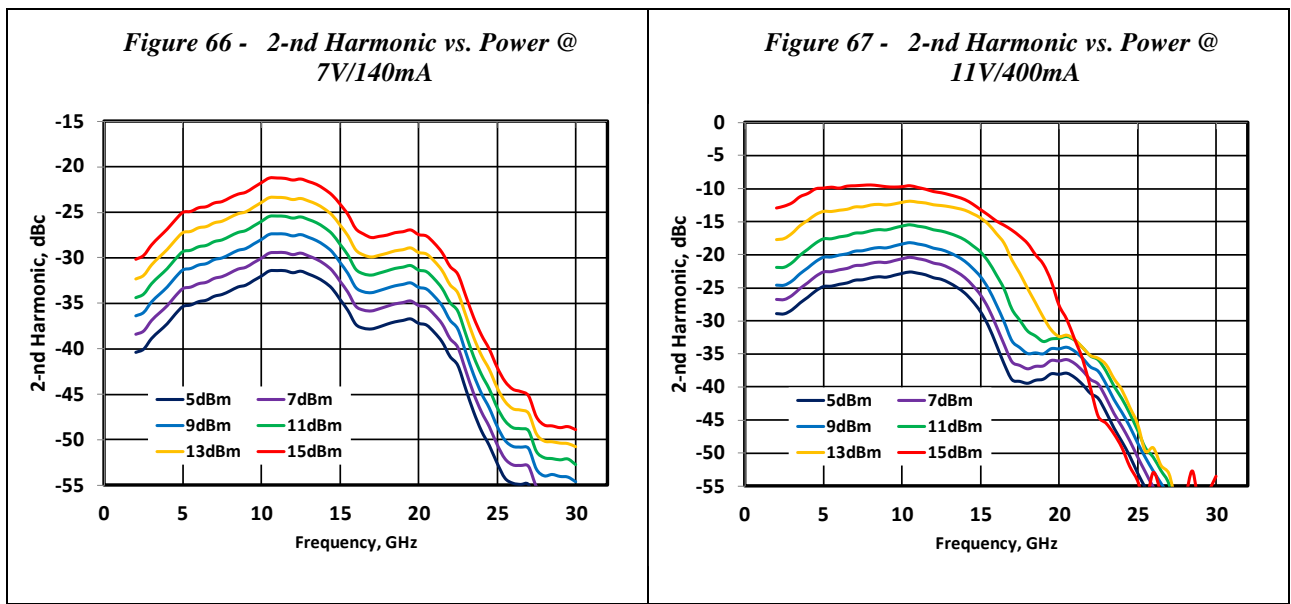

Figure 65 - 2-nd Harmonic vs. Power @ 6V/120mA





### 1.4. Die Specifications

The following illustration shows the chip outline of the MMA041AA device. Dimensions are in millimeters and are relative to the zero datum locations shown in the drawing. The minimum bond pad size is 0.1 mm × 0.1 mm. Both the bond pad surface and the backside metal are 3 μm gold. The die thickness is 0.1 mm. The backside is the DC/RF ground. The airbridge keep-out polygon region is shown inside.

For additional packaging information, contact your Microchip sales representative.

PAD NO.	DESCRIPTION	PAD SIZES
1	GND	0.1x0.1
2	RFIN	0.1x0.1
3	GND	0.1x0.1
4	VDD	0.1x0.1
5	GND	0.1x0.1
6	RFOUT	0.1x0.15
7	GND	0.1x0.1
8	VSB	0.1x0.1
9	VGA	0.1x0.1
10	VGB	0.1x0.1
11	GNDB	0.1x0.1
12	GNDA	0.1x0.1

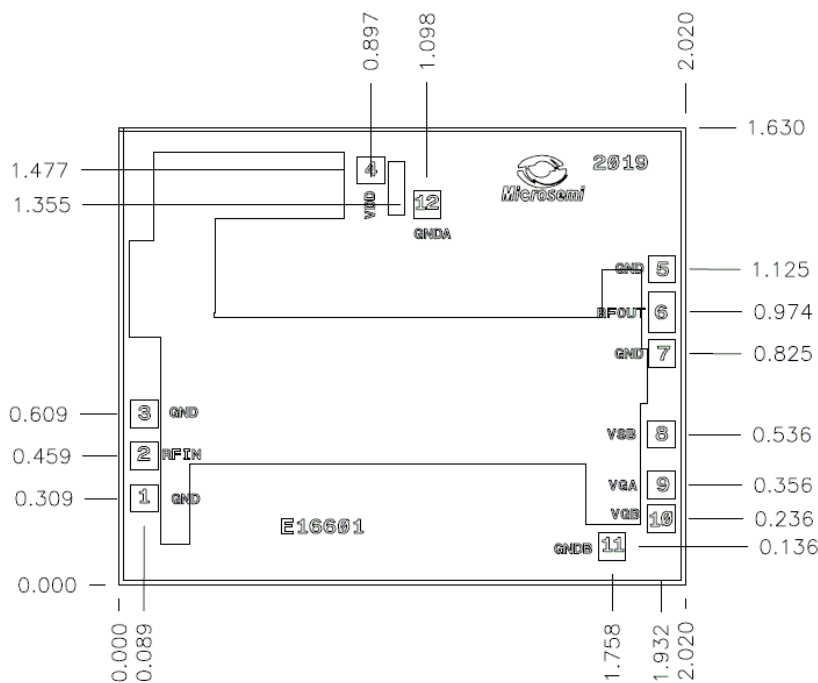

Figure 68 - Die Outline Drawing (mm)

Table 3 - I/O Description

Pad Number	Pad Name	Pad Description
2	RFIN	This pad is DC-decoupled and matched to 50 Ohm.
6	RFOUT	This pad is DC-decoupled and matched to 50 Ohm.
4	VDD	VDD Supply
8	VSB	Used to Set IDD through external optional resistor RSB, see Table 5 below
9, 10	VGA, VGB	Access to Gate 1 bias, Connect to Ground either one for nominal operation. See drawing on Figure 70 -Figure 69 - for correct bond-wire orientation
1, 3, 5, 7, 11, 12	Ground	RF/DC Ground pads, not used in typical applications
Backside Paddle	RF/DC GND	Must be connected to RF/DC Ground

## 2. Application Circuits

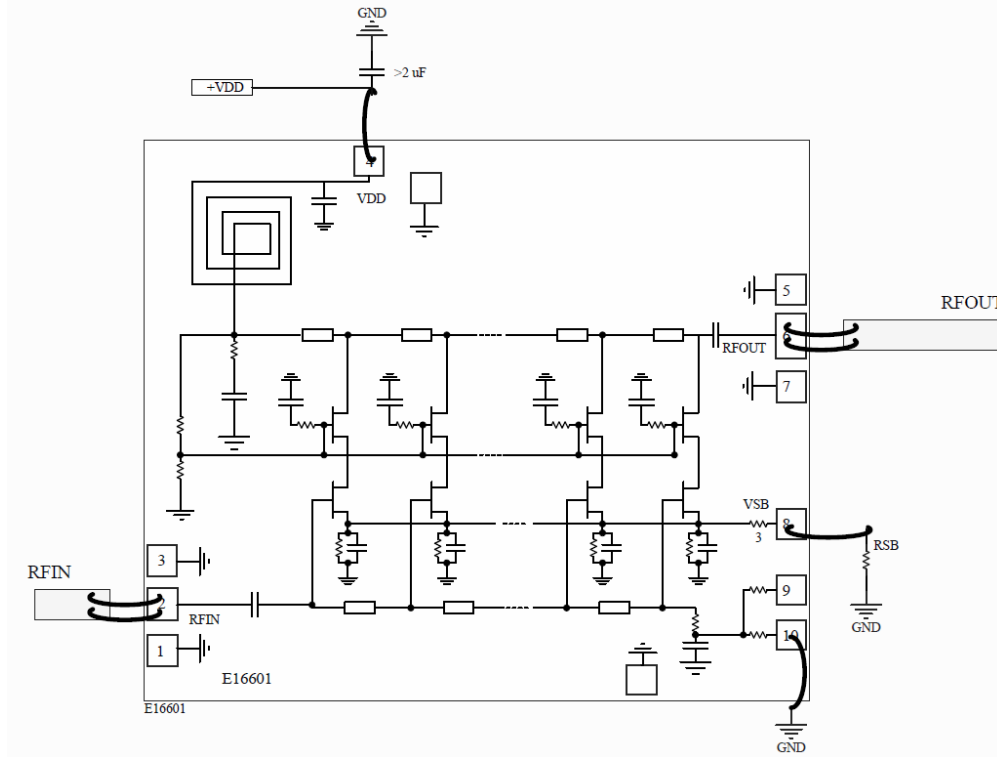

Figure 69 - Application Circuit: Schematic

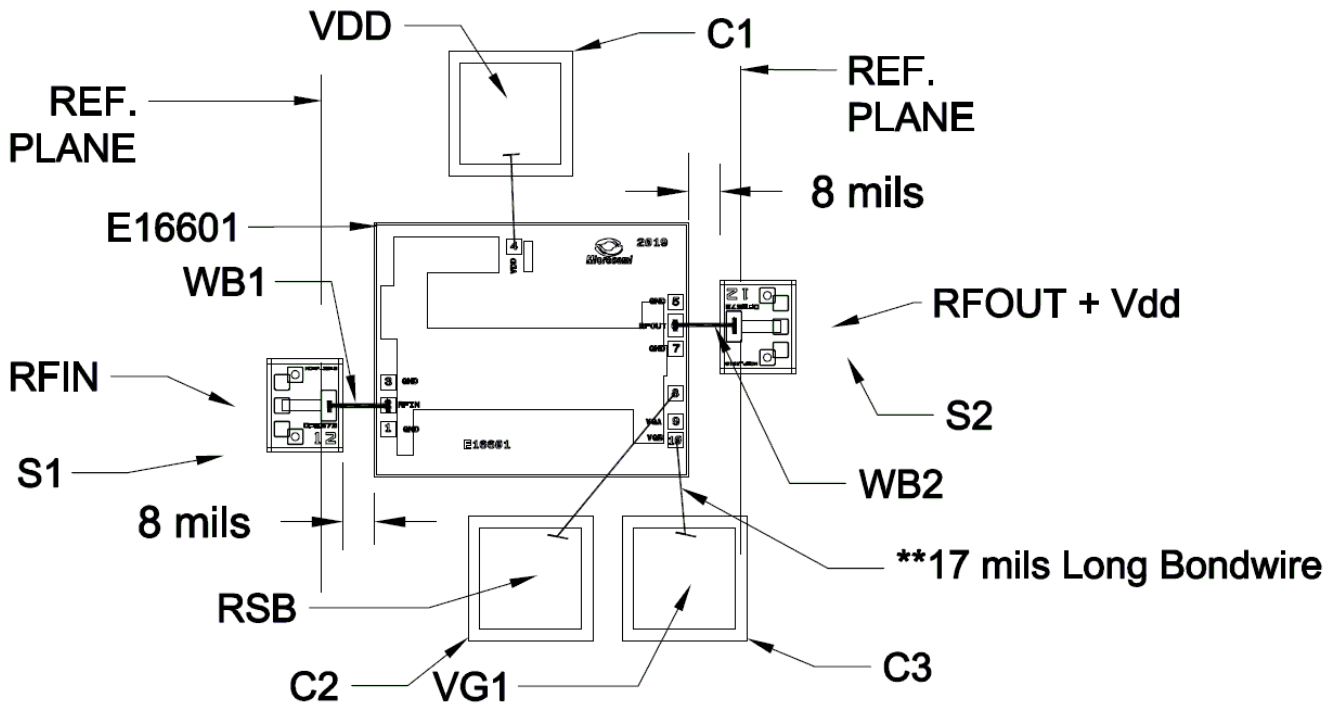

Figure 70 - Test Circuits 2-26 GHz: Assembly Drawing

Table 4 – List of Material for Figure 70: Assembly Drawing

Reference	Part Number	Description
E16601	MMA042AA	Amplifier Die
C1...C3	160U02A102MT4W	Johanson Dielectric SLC 1nF (Values could be different from the Application Circuit Schematic for ease of Test Circuit Assembly)
S1, S2	E57312	Microchip Probe Launchers, calibrated with TRL kit to Ref. Planes shown
WB1, WB2	744-903-06	Microchip 2mils Gold Ribbon, Should be as short as possible
RFIN/RFOUT		Location of the Input/Output GSG (150um) probes
VG1		Needle contact location for DC connection to VG1 (should be grounded if not used)
RSB		Contact for complimentary Resistor (RSB) connection see table 5 below

Table 5 – RSB Values vs Drain Current at 5, 6, 7V

RSB (Ohm)	IDD(mA) at 5V	IDD(mA) at 6V	IDD(mA) at 7V
0	130	131	136
1	122	125	129
2	116	120	123
3	112	115	119
4	108	112	116
5	106	109	113
6	103	107	110
7	101	104	108
8	100	103	106
9	98	101	105
10	96	100	103
11	95	98	102
12	94	97	101
13	93	97	100
14	92	96	99
15	92	95	98
16	91	94	97
17	90	94	97
18	90	93	96
19	89	92	96
20	89	92	95

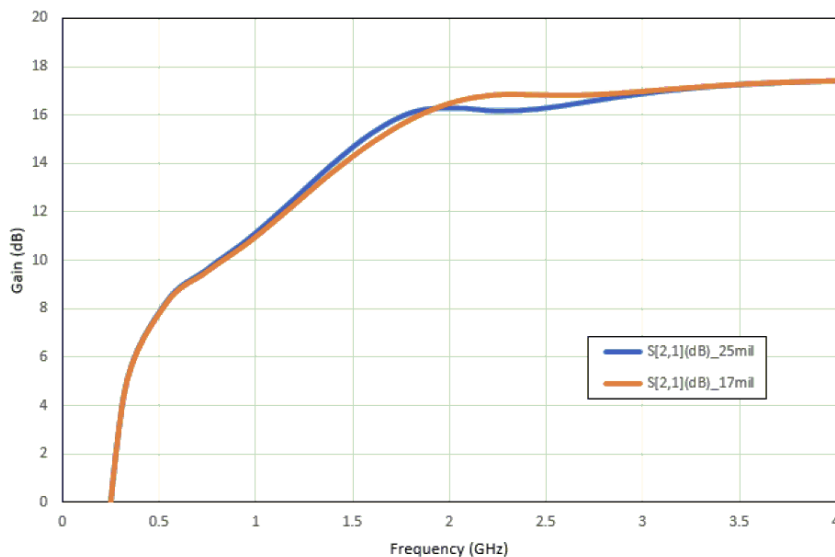

Figure 71 - Low Frequency S21: Comparison of 17 and 25 mils Bond-wire at VGB at 6V/120mA

---

### **3. Handling Recommendations**

Gallium arsenide integrated circuits are sensitive to electrostatic discharge (ESD) and can be damaged by static electricity. It is recommended to follow all procedures and guidelines outlined in the Microsemi application note AN01: GaAs MMIC Handling and Die Attach Recommendations.

### **4. Ordering Information**

For additional ordering information, contact your Microchip sales representative.

<b>Part Number</b>	<b>Package</b>
MMA042AA	Die

#### **4.1. Packing Information**

<b>Standard Format</b>
Gel Pack
50 Pieces per Pack

---

## The Microchip Website

---

Microchip provides online support via our website at [www.microchip.com/](http://www.microchip.com/). This website is used to make files and information easily available to customers. Some of the content available includes:

- **Product Support** – Data sheets and errata, application notes and sample programs, design resources, user’s guides and hardware support documents, latest software releases and archived software
- **General Technical Support** – Frequently Asked Questions (FAQs), technical support requests, online discussion groups, Microchip design partner program member listing
- **Business of Microchip** – Product selector and ordering guides, latest Microchip press releases, listing of seminars and events, listings of Microchip sales offices, distributors and factory representatives

---

## Product Change Notification Service

---

Microchip’s product change notification service helps keep customers current on Microchip products. Subscribers will receive email notification whenever there are changes, updates, revisions or errata related to a specified product family or development tool of interest.

To register, go to [www.microchip.com/pcn](http://www.microchip.com/pcn) and follow the registration instructions.

---

## Customer Support

---

Users of Microchip products can receive assistance through several channels:

- Distributor or Representative
- Local Sales Office
- Embedded Solutions Engineer (ESE)
- Technical Support Customers should contact their distributor, representative or ESE for support. Local sales offices are also available to help customers. A listing of sales offices and locations is included in this document.

Technical support is available through the website at: [www.microchip.com/support](http://www.microchip.com/support)

---

## Microchip Devices Code Protection Feature

---

Note the following details of the code protection feature on Microchip devices:

- Microchip products meet the specifications contained in their particular Microchip Data Sheet.
- Microchip believes that its family of products is secure when used in the intended manner and under normal conditions.
- There are dishonest and possibly illegal methods being used in attempts to breach the code protection features of the Microchip devices. We believe that these methods require using the Microchip products in a manner outside the operating specifications contained in Microchip’s Data Sheets. Attempts to breach these code protection features, most likely, cannot be accomplished without violating Microchip’s intellectual property rights.
- Microchip is willing to work with any customer who is concerned about the integrity of its code.
- Neither Microchip nor any other semiconductor manufacturer can guarantee the security of its code. Code protection does not mean that we are guaranteeing the product is “unbreakable.” Code protection is constantly evolving. We at Microchip are committed to continuously improving the code protection features of our products. Attempts to break Microchip’s code protection feature may be a violation of the Digital Millennium Copyright Act. If such acts allow unauthorized access to your software or other copyrighted work, you may have a right to sue for relief under that Act.

---

## Legal Notice

---

Information contained in this publication is provided for the sole purpose of designing with and using Microchip products. Information regarding device applications and the like is provided only for your convenience and may be superseded by updates. It is your responsibility to ensure that your application meets with your specifications.

THIS INFORMATION IS PROVIDED BY MICROCHIP “AS IS”. MICROCHIP MAKES NO REPRESENTATIONS OR WARRANTIES OF ANY KIND WHETHER EXPRESS OR IMPLIED, WRITTEN OR ORAL, STATUTORY

OR OTHERWISE, RELATED TO THE INFORMATION INCLUDING BUT NOT LIMITED TO ANY IMPLIED WARRANTIES OF NON-INFRINGEMENT, MERCHANTABILITY, AND FITNESS FOR A PARTICULAR PURPOSE OR WARRANTIES RELATED TO ITS CONDITION, QUALITY, OR PERFORMANCE.

IN NO EVENT WILL MICROCHIP BE LIABLE FOR ANY INDIRECT, SPECIAL, PUNITIVE, INCIDENTAL OR CONSEQUENTIAL LOSS, DAMAGE, COST OR EXPENSE OF ANY KIND WHATSOEVER RELATED TO THE INFORMATION OR ITS USE, HOWEVER CAUSED, EVEN IF MICROCHIP HAS BEEN ADVISED OF THE POSSIBILITY OR THE DAMAGES ARE FORESEEABLE. TO THE FULLEST EXTENT ALLOWED BY LAW, MICROCHIP'S TOTAL LIABILITY ON ALL CLAIMS IN ANY WAY RELATED TO THE INFORMATION OR ITS USE WILL NOT EXCEED THE AMOUNT OF FEES, IF ANY, THAT YOU HAVE PAID DIRECTLY TO MICROCHIP FOR THE INFORMATION. Use of Microchip devices in life support and/or safety applications is entirely at the buyer's risk, and the buyer agrees to defend, indemnify and hold harmless Microchip from any and all damages, claims, suits, or expenses resulting from such use. No licenses are conveyed, implicitly or otherwise, under any Microchip intellectual property rights unless otherwise stated.

## Trademarks

The Microchip name and logo, the Microchip logo, Adaptec, AnyRate, AVR, AVR logo, AVR Freaks, BesTime, BitCloud, chipKIT, chipKIT logo, CryptoMemory, CryptoRF, dsPIC, FlashFlex, flexPWR, HELDO, IGLOO, JukeBlox, KeeLoq, Klear, LANCheck, LinkMD, maXStylus, maXTouch, MediaLB, megaAVR, Microsemi, Microsemi logo, MOST, MOST logo, MPLAB, OptoLyzer, PackeTime, PIC, picoPower, PICSTART, PIC32 logo, PolarFire, Prochip Designer, QTouch, SAM-BA, SenGenuity, SpyNIC, SST, SST Logo, SuperFlash, Symmetricom, SyncServer, Tachyon, TempTrackr, TimeSource, tinyAVR, UNI/O, Vectron, and XMEGA are registered trademarks of Microchip Technology Incorporated in the U.S.A. and other countries.

APT, ClockWorks, The Embedded Control Solutions Company, EtherSynch, FlashTec, Hyper Speed Control, HyperLight Load, IntelliMOS, Libero, motorBench, mTouch, Powermite 3, Precision Edge, ProASIC, ProASIC Plus, ProASIC Plus logo, Quiet-Wire, SmartFusion, SyncWorld, Temux, TimeCesium, TimeHub, TimePictra, TimeProvider, Vite, WinPath, and ZL are registered trademarks of Microchip Technology Incorporated in the U.S.A.

Adjacent Key Suppression, AKS, Analog-for-the-Digital Age, Any Capacitor, AnyIn, AnyOut, BlueSky, BodyCom, CodeGuard, CryptoAuthentication, CryptoAutomotive, CryptoCompanion, CryptoController, dsPICDEM, dsPICDEM.net, Dynamic Average Matching, DAM, ECAN, EtherGREEN, In-Circuit Serial Programming, ICSP, INICnet, Inter-Chip Connectivity, JitterBlocker, KlearNet, KlearNet logo, memBrain, Mindi, MiWi, MPASM, MPF, MPLAB Certified logo, MPLIB, MPLINK, MultiTRAK, NetDetach, Omniscient Code Generation, PICDEM, PICDEM.net, PICkit, PICtail, PowerSmart, PureSilicon, QMatrix, REAL ICE, Ripple Blocker, SAM-ICE, Serial Quad I/O, SMART-I.S., SQI, SuperSwitcher, SuperSwitcher II, Total Endurance, TSHARC, USBCheck, VariSense, ViewSpan, WiperLock, Wireless DNA, and ZENA are trademarks of Microchip Technology Incorporated in the U.S.A. and other countries.

SQTP is a service mark of Microchip Technology Incorporated in the U.S.A.

The Adaptec logo, Frequency on Demand, Silicon Storage Technology, and Symmcom are registered trademarks of Microchip Technology Inc. in other countries.

GestIC is a registered trademark of Microchip Technology Germany II GmbH & Co. KG, a subsidiary of Microchip Technology Inc., in other countries.

All other trademarks mentioned herein are property of their respective companies.

© 2021, Microchip Technology Incorporated, Printed in the U.S.A., All Rights Reserved. ISBN:

## Quality Management System

For information regarding Microchip's Quality Management Systems, please visit [www.microchip.com/quality](http://www.microchip.com/quality).

**Worldwide Sales and Service**

AMERICAS	ASIA/PACIFIC	ASIA/PACIFIC	EUROPE
Corporate Office 2355 West Chandler Blvd. Chandler, AZ 85224-6199 Tel: 480-792-7200 Fax: 480-792-7277 Technical Support: <a href="http://www.microchip.com/support">www.microchip.com/support</a> Web Address: <a href="http://www.microchip.com">www.microchip.com</a> Atlanta Duluth, GA Tel: 678-957-9614 Fax: 678-957-1455 Austin, TX Tel: 512-257-3370 Boston Westborough, MA Tel: 774-760-0087 Fax: 774-760-0088 Chicago Itasca, IL Tel: 630-285-0071 Fax: 630-285-0075 Dallas Addison, TX Tel: 972-818-7423 Fax: 972-818-2924 Detroit Novi, MI Tel: 248-848-4000 Houston, TX Tel: 281-894-5983 Indianapolis Noblesville, IN Tel: 317-773-8323 Fax: 317-773-5453 Tel: 317-536-2380 Los Angeles Mission Viejo, CA Tel: 949-462-9523 Fax: 949-462-9608 Tel: 951-273-7800 Raleigh, NC Tel: 919-844-7510 New York, NY Tel: 631-435-6000 San Jose, CA Tel: 408-735-9110 Tel: 408-436-4270 Canada - Toronto Tel: 905-695-1980 Fax: 905-695-2078	Australia - Sydney Tel: 61-2-9868-6733 China - Beijing Tel: 86-10-8569-7000 China - Chengdu Tel: 86-28-8665-5511 China - Chongqing Tel: 86-23-8980-9588 China - Dongguan Tel: 86-769-8702-9880 China - Guangzhou Tel: 86-20-8755-8029 China - Hangzhou Tel: 86-571-8792-8115 China - Hong Kong SAR Tel: 852-2943-5100 China - Nanjing Tel: 86-25-8473-2460 China - Qingdao Tel: 86-532-8502-7355 China - Shanghai Tel: 86-21-3326-8000 China - Shenyang Tel: 86-24-2334-2829 China - Shenzhen Tel: 86-755-8864-2200 China - Suzhou Tel: 86-186-6233-1526 China - Wuhan Tel: 86-27-5980-5300 China - Xian Tel: 86-29-8833-7252 China - Xiamen Tel: 86-592-2388138 China - Zhuhai Tel: 86-756-3210040	India - Bangalore Tel: 91-80-3090-4444 India - New Delhi Tel: 91-11-4160-8631 India - Pune Tel: 91-20-4121-0141 Japan - Osaka Tel: 81-6-6152-7160 Japan - Tokyo Tel: 81-3-6880-3770 Korea - Daegu Tel: 82-53-744-4301 Korea - Seoul Tel: 82-2-554-7200 Malaysia - Kuala Lumpur Tel: 60-3-7651-7906 Malaysia - Penang Tel: 60-4-227-8870 Philippines - Manila Tel: 63-2-634-9065 Singapore Tel: 65-6334-8870 Taiwan - Hsin Chu Tel: 886-3-577-8366 Taiwan - Kaohsiung Tel: 886-7-213-7830 Taiwan - Taipei Tel: 886-2-2508-8600 Thailand - Bangkok Tel: 66-2-694-1351 Vietnam - Ho Chi Minh Tel: 84-28-5448-2100	Austria - Wels Tel: 43-7242-2244-39 Fax: 43-7242-2244-393 Denmark - Copenhagen Tel: 45-4485-5910 Fax: 45-4485-2829 Finland - Espoo Tel: 358-9-4520-820 France - Paris Tel: 33-1-69-53-63-20 Fax: 33-1-69-30-90-79 Germany - Garching Tel: 49-8931-9700 Germany - Haan Tel: 49-2129-3766400 Germany - Heilbronn Tel: 49-7131-72400 Germany - Karlsruhe Tel: 49-721-625370 Germany - Munich Tel: 49-89-627-144-0 Fax: 49-89-627-144-44 Germany - Rosenheim Tel: 49-8031-354-560 Israel - Ra'anana Tel: 972-9-744-7705 Italy - Milan Tel: 39-0331-742611 Fax: 39-0331-466781 Italy - Padova Tel: 39-049-7625286 Netherlands - Drunen Tel: 31-416-690399 Fax: 31-416-690340 Norway - Trondheim Tel: 47-72884388 Poland - Warsaw Tel: 48-22-3325737 Romania - Bucharest Tel: 40-21-407-87-50 Spain - Madrid Tel: 34-91-708-08-90 Fax: 34-91-708-08-91 Sweden - Gothenberg Tel: 46-31-704-60-40 Sweden - Stockholm Tel: 46-8-5090-4654 UK - Wokingham Tel: 44-118-921-5800 Fax: 44-118-921-5820